

AS A226 flush mounted profile can easily be applied to all types of floors and load bearing capacity is designed for cars or pedestrians depending on the gap inquired. Adjustable interlocking profile and gasket configuration makes it available for very large openings and enables to meet displacements in 3 directions. If inquired, AS A226 can be applied with wall type AS A126 and this dual application brings in a decorative aspect. Profiles are delivered factory-assembled.

- Application Areas** : Indoor & Outdoor / Floor
- Ideal for** : Car Parks, Shopping Malls, Airports, Residences, Hospitals, Hotels, Public & Commercial Buildings etc.
- Material** : Mill Finish Aluminum (Anodizing optional), TPE Gasket
- Aluminum Alloy** : 6063 AA-USA / EN AW 6063
- Optional Supplies** : Fire Barrier, Waterproof EPDM membrane

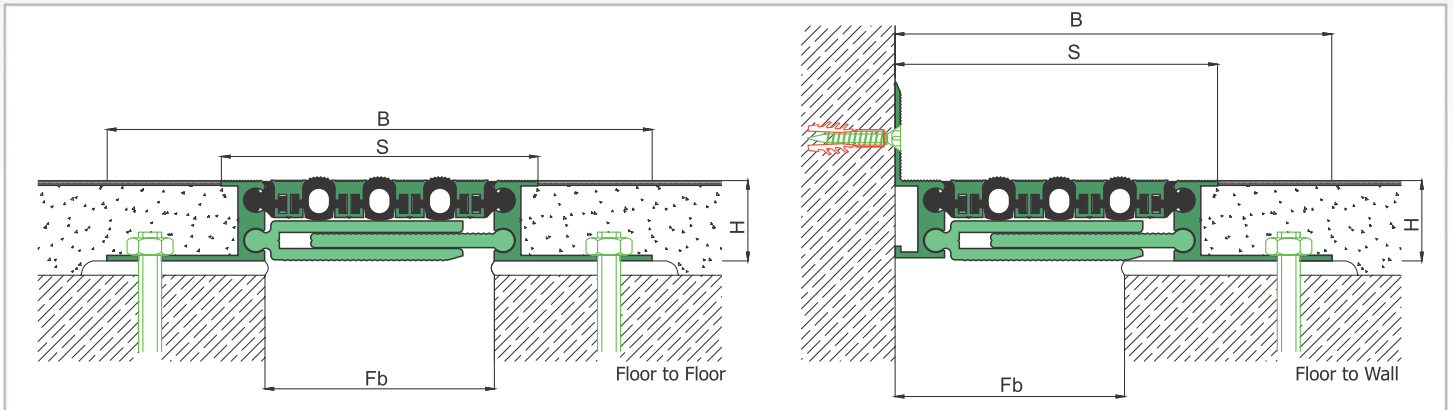

\* Visuals are representative and the profile configuration may differ depending on the characteristics requested.

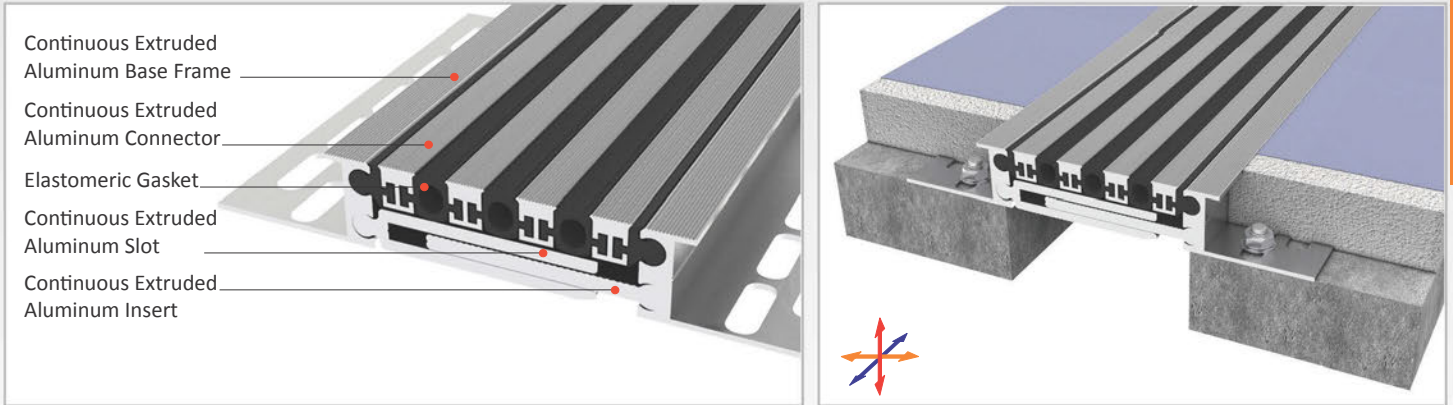

LOCATION	MODEL	GAP (Fb) mm	HEIGHT (H) MM	OVERALL WIDTH (B) mm	VISIBLE WIDTH (S) mm	MOVEMENT (W) mm	LOAD CAPACITY	STANDARD LENGTH (mt)
Floor to Floor	AS A226-040	40	28	150	70	± 4		3
	AS A226-060	60	28	170	90	± 6		3
	AS A226-080	80	28	190	110	± 8		3
	AS A226-100	100	28	210	130	± 10		3
	AS A226-120	120	28	230	150	± 12		3
	AS A226-140	140	28	256	176	± 14		3
	AS A226-160	160	28	278	199	± 16		3
	AS A226-180	180	28	298	219	± 18		3
	AS A226-200	200	28	318	238	± 20		3

Note: Please ask for different sizes

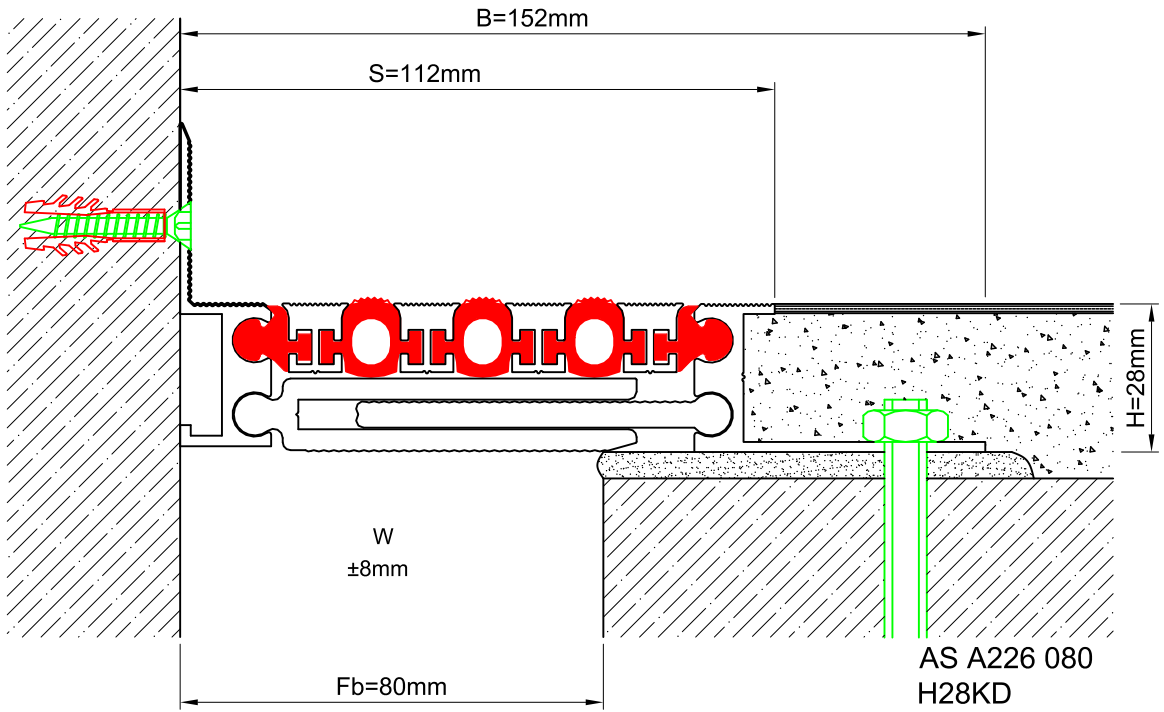
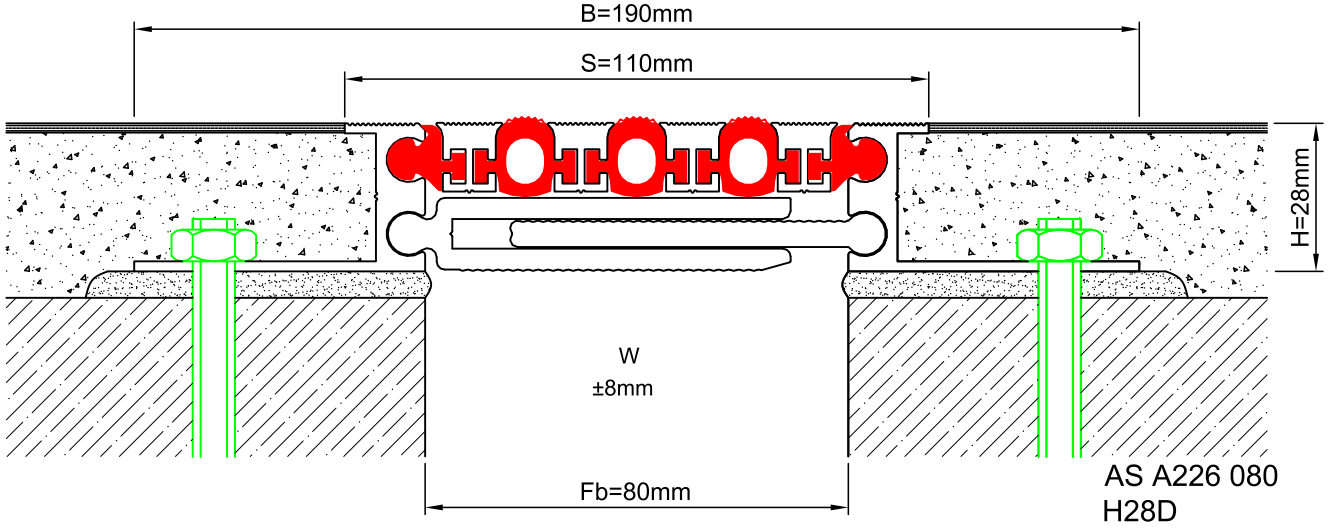

Profil No Profile Number	AS A226 080	AS A226 080K
Fb (mm)	80	80
H (mm) yaklaşık approx.	28	28
W± (mm) yaklaşık approx.	±8	±8
Renk Color	Alüminyum: Natürel, Fitiller: Siyah, gri, diğer Aluminum: Natural, Inserts: Black, grey, others	
Malzeme Material	Alüminyum, TPE Termoplastik Elastomer Aluminum, TPE Thermoplastic Elastomer	
Standart Uzunluk Standard Length	3	
Yükleme Kapasitesi Load-Bearing Capacity	